

## 4/3 and 4/2 Directional Valves with wet pinDC or AC solenoids, Type 4WE 6 or 10

### ■ Product show and brief introduction

---

Size 6,10  
Component series 6X/3X  
Maximum operating pressure 35 MPa  
Maximum flow 120 L/min

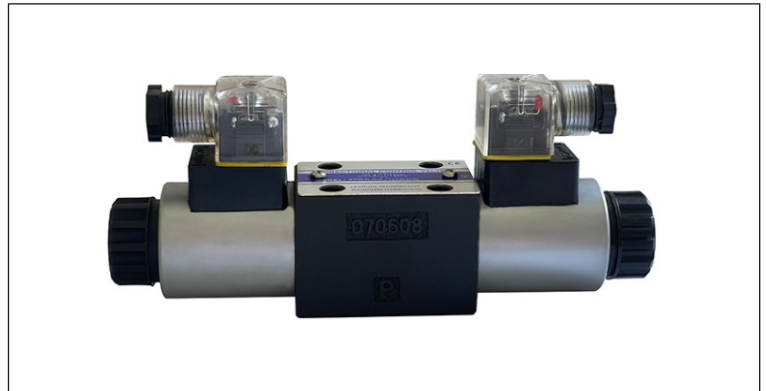

### ■ Features

---

- Three position four way two position four way or two position three way odeml
- High power coil, can rotate 90°
- Electrical connections as single or pair connections
- Manual emergency operation, optional
- Low voltage directive 201435EU for symbol CE when voltage >50VAC or >75VDC

## Ordering details

1	2	3	4	5	6	7	8	9	10	11	12	13	14	15
4WE				/										

Item	Collocation	Code	Explanation
1	Sort	4WE	4/3 and 4/2 Solenoid operated directional valve
2	Nominal size	6	
		10	
3	Operated Directional Cushion	No Code	Standard
		S	Cushion operated directional Impact is small.
4	Symbols		See symbols list
5	Series	6X	For nominal size 6
		3X	For nominal size 10
6	Return mode	No Code	Spring Return
		O	Without Spring Return
		OF	With detent
7		E	For nominal size 6 , high power solenoid
		C	For nominal size 10
8	Input voltage	W220	220V/50Hz、240V/60Hz
		W110	110V/50Hz、120V/60Hz
		RAC220	220V/50Hz、240V/60Hz
		RAC110	110V/50Hz、120V/60Hz
		G12	12V
		G24	24V
9	Hand override	N9	With protected hand override (standard)
		N	With hand override

  

Item	Collocation	Code	Explanation
10	Electrical connections	K4	Individual connections with component plug ISO4400 without plug-in connector
		DL	Central connections Terminal box with cable connector, with indicator light
11	Plug-in connector	No Code	Without plug-in connector
		Z4	With quadrate plug-in connector
		Z5L	Quadrate plug-in connector with indicator light
		F6L	With waterproof <sup>①</sup> plug-in connector
12	Throttle position	No Code	Without cartridge throttle
		P	Active in the P line
		A	Active in the A line
		B	Active in the B line
13	Throttle diameter	No Code	Without cartridge throttle
		08	Throttle $\varnothing$ 0.8 mm
		10	Throttle $\varnothing$ 1.0 mm
		12	Throttle $\varnothing$ 1.2 mm
14	Seal material	No Code	NBR seals
		V	FKM seals
15			Description of other special requirements

### Note:

① Waterproof degree of plug-in connector is IP65;

**Symbols**

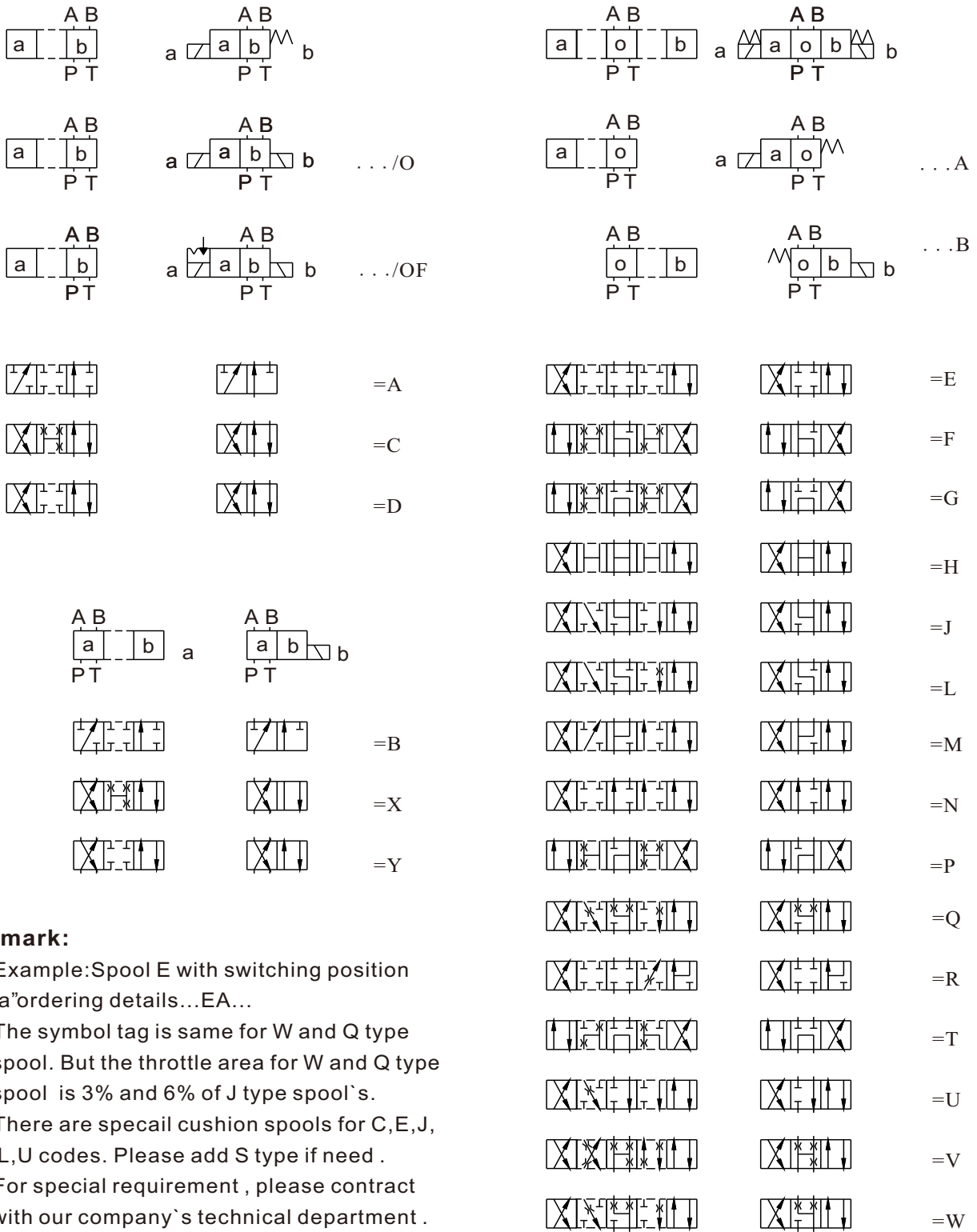

**Remark:**

1. Example: Spool E with switching position "a" ordering details...EA...
2. The symbol tag is same for W and Q type spool. But the throttle area for W and Q type spool is 3% and 6% of J type spool's.
3. There are special cushion spools for C,E,J, L,U codes. Please add S type if need .
4. For special requirement , please contract with our company's technical department . We can design special spool .

## Function, section

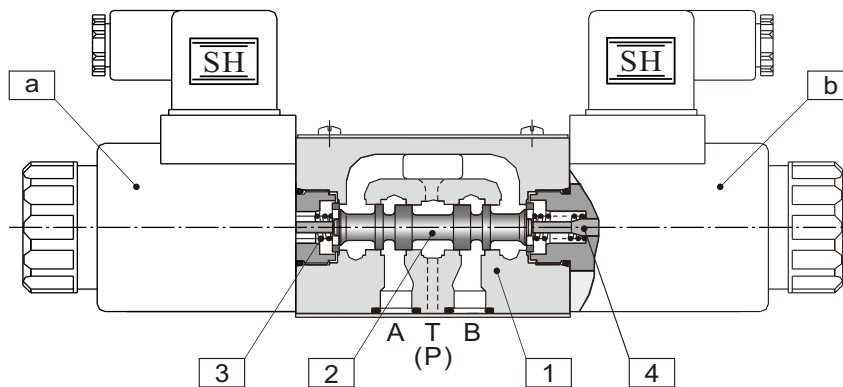

Section photo 3 Type4:WE 6 .....6X/.....Z5LS

### Function description

On the section photo 3, the solenoid power which is brought after solenoid 'a' or solenoid 'b' gets through electricity can drive the control spool 2 to move right or left inside housing 1 pass plunger 4. So it can flow freely from P to B, A to T or P to A, B to T.

There are three kinds of return type for spool when de-energising solenoid. Spring return type: return spring 3 drive spool back to the initial position; Without spring return type: the spool position when solenoids are de-energised is not defined; Detent or type: spool can keep any position when solenoid stops electricity.

### Spring Return Type (4WE .../...)

For this kind return type solenoid operated directional valve, solenoid power conquers spring power to drive spool when solenoid gets through electricity. The spool comes back and keeps at one end (two position valve) or middle position (three position valve) because of spring power after solenoid loses electricity.

### Without Spring Return Type (4WE .../O...)

For this kind return type solenoid operated directional valve, solenoid power drives spool to needed position directly when solenoid gets through electricity. There isn't fixed position after solenoid loses electricity.

### Orientation Organ Type (4WE .../OF...)

For this kind return type solenoid operated directional valve, solenoid power drives spool to needed position directly when solenoid gets through electricity. After that, when solenoids are de-energised, the spool is held in the detent position and thus the solenoids do not need to be continuously energised.

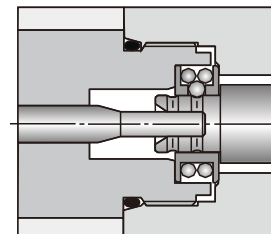

Section photo 4 : detent

### Cartridge throttle (4WE ...P08...)

In some fixed work condition hydraulic system, please insert right throttler into P.A.B oil port base on detail situation when the flows exceed permitted power limit of the valve during operation (see section photo 5).

There are three dimensions for damper are 0.8、1.0、1.2(mm)

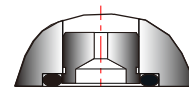

Section photo 5 : throttle

## Technical data

General			Size 6	Size 10
Weight	Valve with 1 solenoids	Kg	1.65	4.80
	Valve with 2 solenoids	Kg	2.25	6.15
Ambient temperature		°C	-30 to 50	
Installation			optional	

Hydraulic			Size 6	Size 10
Flow Max.		L/min	Up to 80(=);Up to 60(~)	Up to 120
Operating pressure max	Ports A、B、P	MPa	35	31.5
	Ports T	MPa	Up to 21(=);Up to 16(~) <sup>③</sup>	
Pressure fluid:			Mineral oil(HL,HLP)to DIN 51524 <sup>①</sup> Fast bio-degradable pressure fluids to VDMA 24568; HETG(rape seed oil) <sup>①</sup> HEPG(Polyglycol);HEES(Synthetic ester) <sup>②</sup> ; Other fluids on request	
Pressure fluid temperature range	NBR seals	°C	-30 to +80	
	FKM seals	°C	-20 to +80	
Viscosity range		mm <sup>2</sup> /s	2.8 to 500	
Degree of fluid contamination			Maximum permissible degree of contamination of fluid is to NAS 1638 class 9.We,therefore,recommend a fither minmun retention rat of $\beta_{10} \geq 25$ .	

Electrical			Size 6		Size 10	
			DC	AC 50/60Hz	DC	AC 50/60Hz
Voltage available		V	12,24,48	110,120,220,240	12,24,48	110,120,220,240
Voltage tolerance (normal voltage)		%	±10	±10	±10	±10
Power consumption		W	32	—	<40	50
Holding current		A	—	—	—	0.9
In-rush current		A	—	<2	—	<2
shifting time to ISO6403	ON	ms	25 to 45	10 to 20	40 to 60	15 to 25
	OFF	ms	10 to 25	15 to 40	20 to 30	20 to 30
shifting frequency		Sw/h	up to 15000	up to 7200	up to 15000	up to 7200
Insulation to DIN 40 050			IP65	IP65	IP65	IP65
Coil temperature		°C	up to +155	up to +180	up to +155	up to +180

**Note:** ③ For with symbols A and B , port T must be used as a drain port,if the operating pressure is above the permssible tank pressure .

**Characteristic Curves** (measured at  $v=41\text{mm}^2/\text{s}$  and  $t=50^\circ\text{C}$ )

**Nominal size 6**

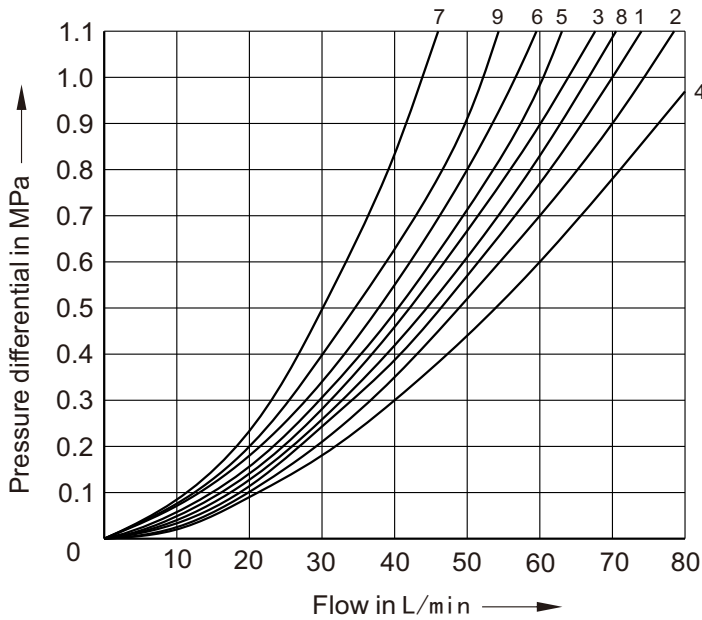

Symbol	Flow Direction				
	P-A	P-B	A-T	B-T	P-T
A、B	3	3	—	—	—
C、X	1	1	3	1	—
D、Y	5	5	3	3	—
E	3	3	1	1	—
F	1	3	1	1	—
G	6	6	8	8	7
H	2	4	2	2	—
J、Q	1	1	2	1	—
L	3	3	4	8	—
M	2	4	3	3	—
P	3	1	1	1	—
R	5	5	4	—	—
T	9	9	8	8	7
U	3	3	8	4	—
V	1	2	1	1	—
W	1	1	2	2	—

**Nominal size 10**

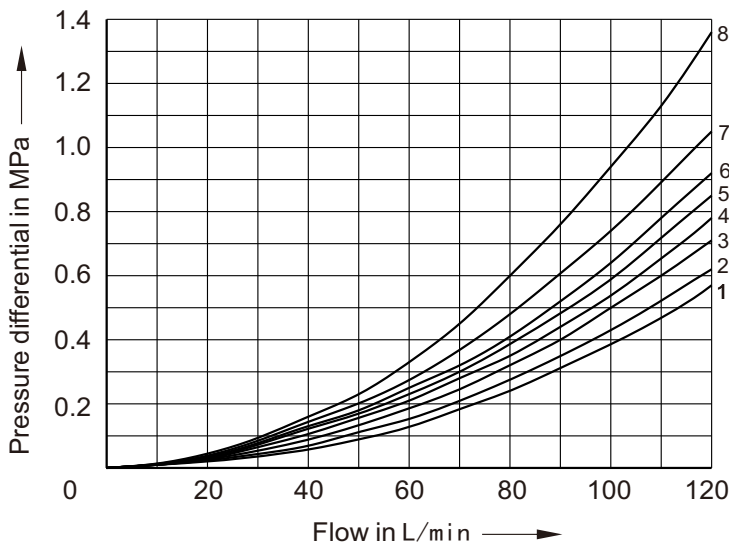

Symbol	Flow Direction				
	P-A	P-B	A-T	B-T	P-T
A、B	3	3	—	—	—
C、X	1	3	4	5	—
D、Y	5	5	6	6	—
E	1	1	4	4	—
F	2	3	7	4	8
G	3	3	6	7	9
H	1	1	6	7	3
J、Q	1	1	3	3	—
L	2	2	3	5	—
M	1	1	4	5	—
P	3	1	1	1	—
R	5	5	4	—	—
T	9	9	8	8	7
U	2	2	3	3	—
V	1	2	1	1	—
W	1	1	2	2	—

**Shifting Power Limits**

○ **Nominal size 6 DC Solenoid & AC Solenoid**

The given switching power limits are for applications with two flow directions, and were measured with the solenoids at operating temperature, 10% under voltage and without tank back pressure.

Measured at  $v=41\text{mm}^2/\text{s}$  and  $t=50^\circ\text{C}$

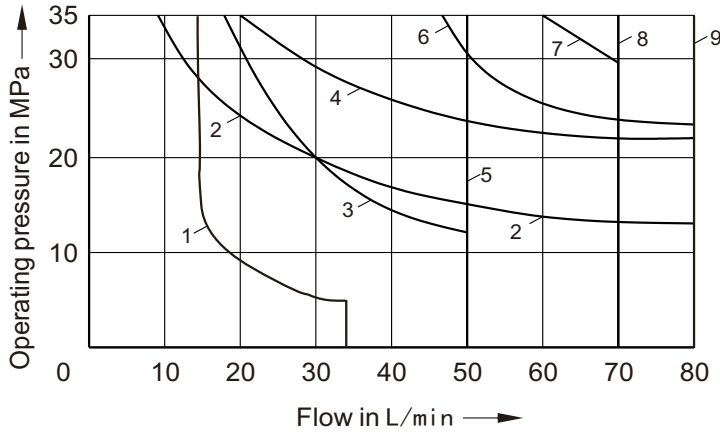

**DC Solenoid**

Curve	Symbol	Curve	Symbol
1	V	6	A/O、A/OF、L、U
2	A、B	7	C、D、Y
3	F、P	8	M
4	J	9	E、C/O、C/OF D/O、D/OF、Q W、R
5	G、H、T		

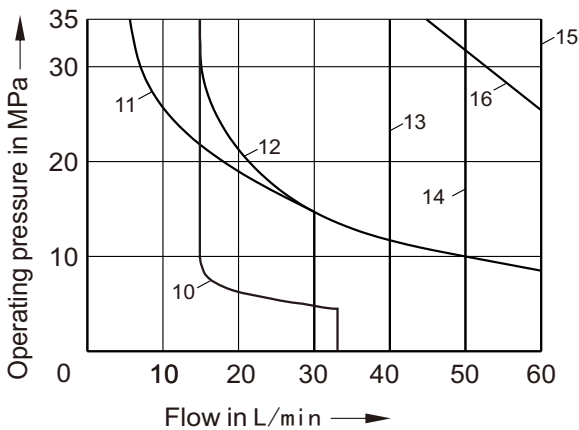

**50Hz AC Solenoid**

Curve	Symbol	Curve	Symbol
10	V	15	A/O、A/OF C/O、C/OF D/O、D/OF M、J、Q、R W、E、L、U
11	A、B		
12	F、P		
13	G、T		
14	H	16	C、D、Y

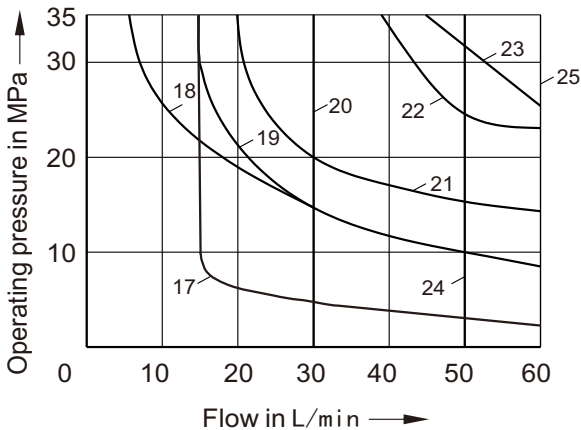

**60Hz AC Solenoid**

Curve	Symbol	Curve	Symbol
17	V	22	A/O、A/OF、Q、W
18	A、B	23	C、D、Y
19	F、P	24	H
20	G、T	25	C/O、C/OF、D/O D/OF、E、M、R
21	L、U、J		

**Shifting Power Limits**

**Nominal size 10 ,DC Solenoid & AC Solenoid**

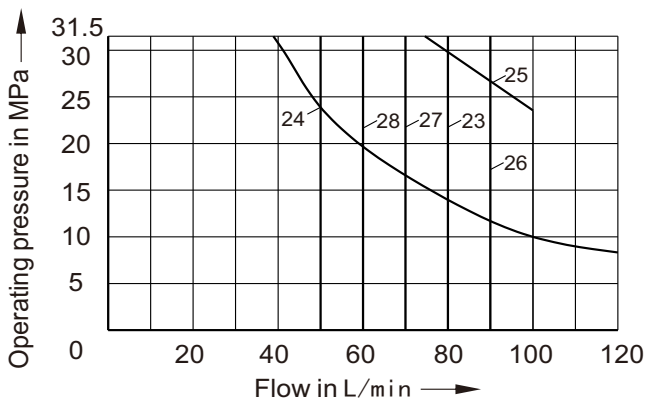
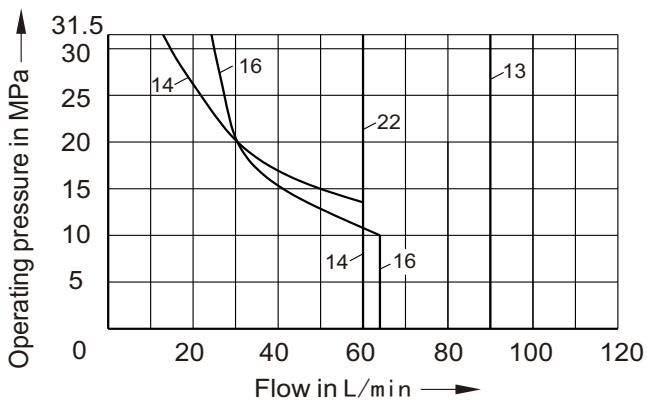
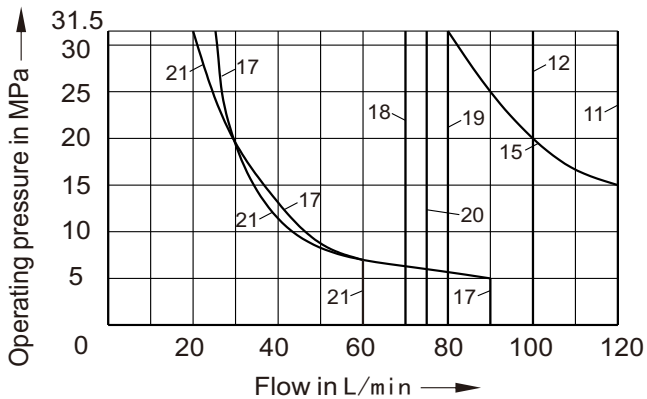
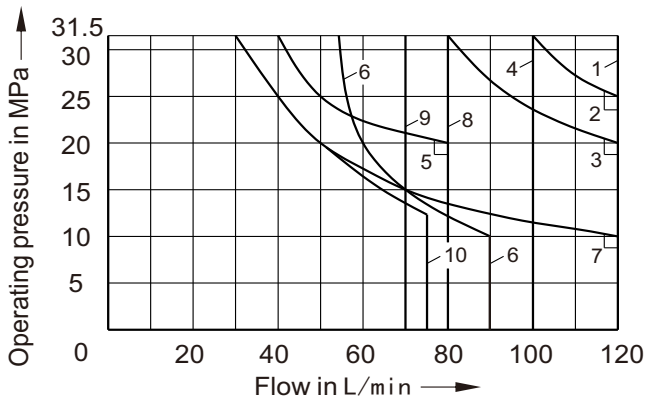

The given switching power limits are for applications with two flow directions, and were measured with the solenoids at operating temperature, 10% under voltage and without tank back pressure.

Measured at  $v=41\text{mm}^2/\text{s}$  and  $t=50^\circ\text{C}$

**DC Solenoid : 24V**

Curve	Symbol	Curve	Symbol
1	C、C/O、C/OF D、D/O、D/OF Y、M	5	G
		6	F、P
2	E	7	A、B
3	A/O、A/OF、L U、J、Q、W	8	R、L、U <sup>①</sup>
		9	V
4	H	10	T

① Only fit for the situation at middle position.

**AC Solenoid :** 110V/50Hz; 120V/60Hz;  
220V/50Hz; 240V/60Hz.

Curve	Symbol	Curve	Symbol
11	C、C/O、C/OF D、D/O、D/OF、Y	16	G
		17	F、P
12	E、L、U Q、W	18	H
		19	R
13	M	20 <sup>①</sup>	L、U
14	A、B	21	T
15	A/O、A/OF、J	22	V

① Only fit for the situation at middle position.

**AC Solenoid :** 110V/60Hz; 220V/60Hz;

Curve	Symbol	Curve	Symbol
23	C、CO、COF、D DO、DOF、Y	26	M
24	AO、AOF	27	H
25	E	28	V



**Installation Dimensions**

● Nominal size 6

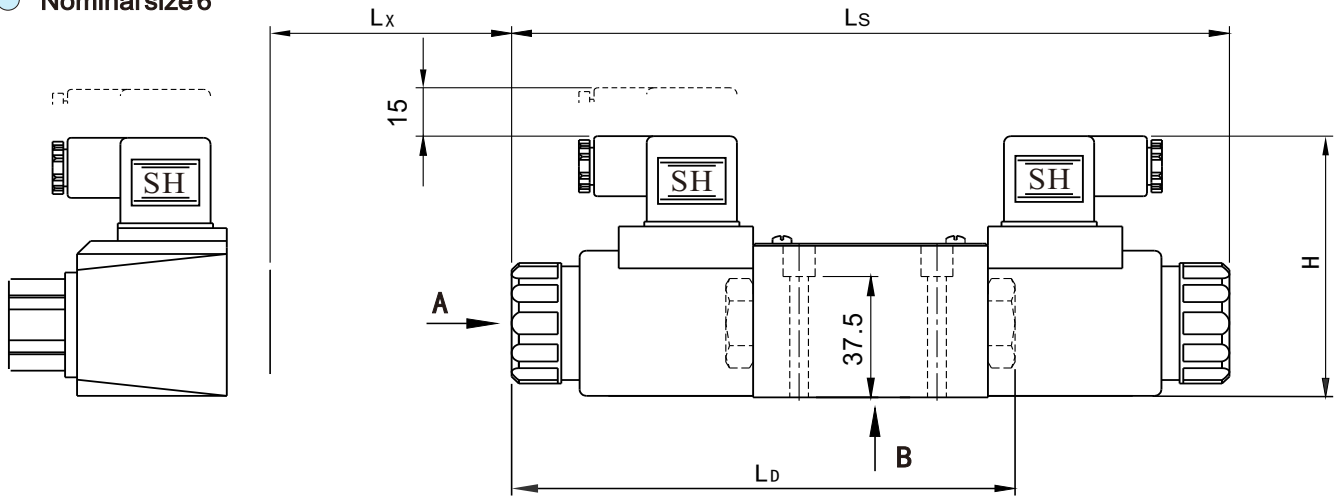

AC Plug-in Connection Type

DC Plug-in Connection Type

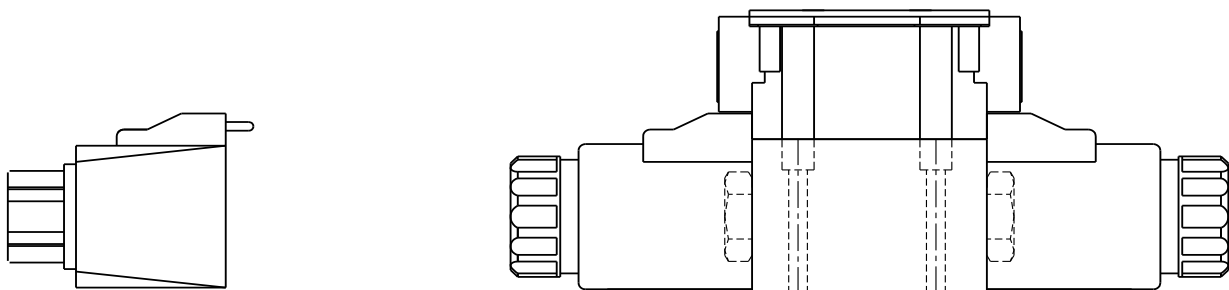

AC With Lamp Central Connection Type

DC With Lamp Central Connection Type

**A Direction**

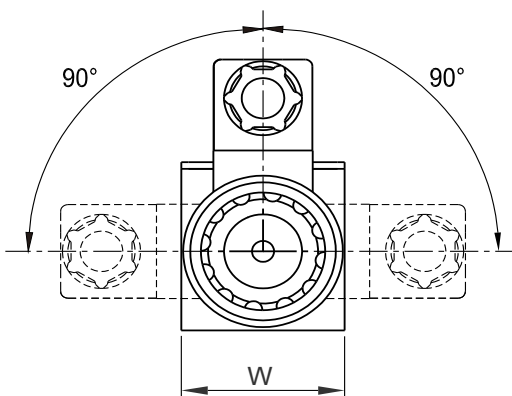

**B Direction**

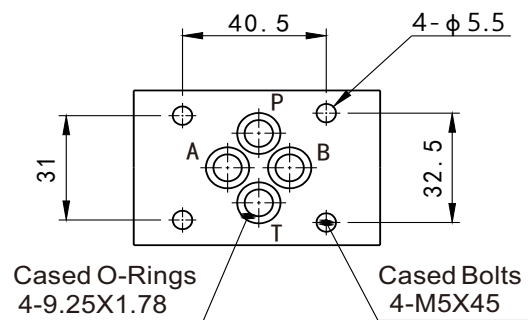

Valve type	Total length		Total width (W)	Total high (H)	Take out coil (Lx)
	L <sub>D</sub>	L <sub>S</sub>			
DC Plug-In Connection Type	148	211	46	81	71
DC With Lamp Central Connection Type	148	211	46	85	71
AC Plug-in Connection Type	141	197	46	81	64
AC With Lamp Central Connection Type	141	197	46	85	64

**Installation Dimensions**

● Nominal size 10

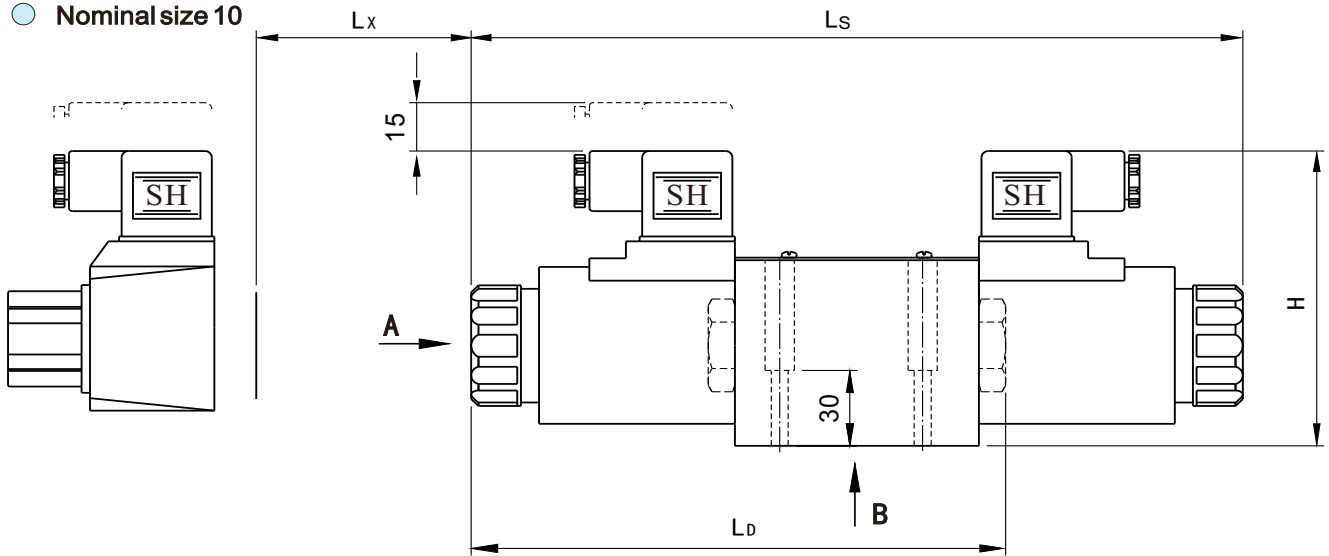

AC Plug-in Connection Type

DC Plug-in Connection Type

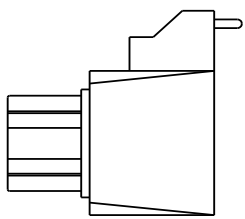

AC With Lamp Central Connection Type

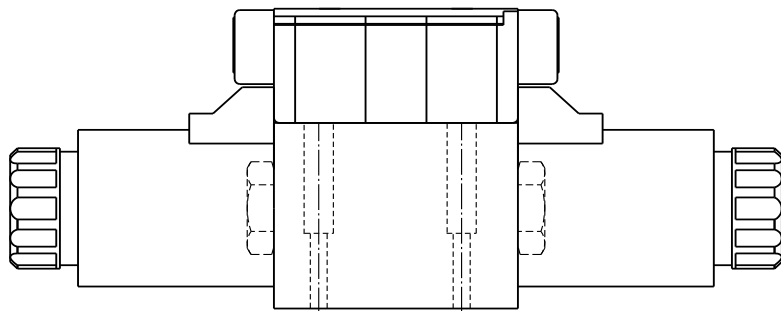

DC With Lamp Central Connection Type

**A Direction**

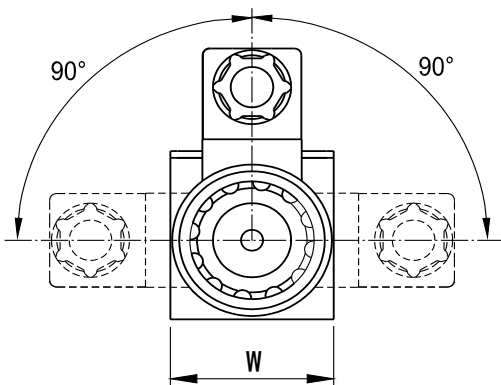

**B Direction**

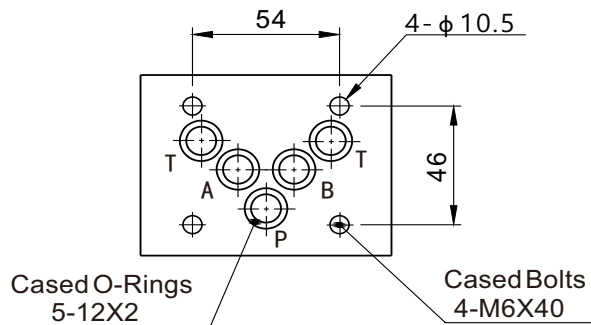

Valve type	Total length		Total width (W)	Total high (H)	Take out coil (Lx)
	Ld	Ls			
DC Plug-In Connection Type	207.3	302	70	111	105
DC With Lamp Central Connection Type	207.3	302	70	119	105
AC Plug-in Connection Type	168.3	224.2	70	111	66
AC With Lamp Central Connection Type	168.3	224.2	70	119	66

**Subplate Installation Dimensions (Porting pattern to ISO 4401)**

● **Nominal size 6**

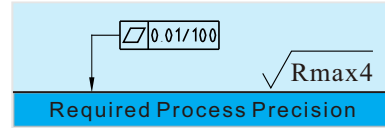
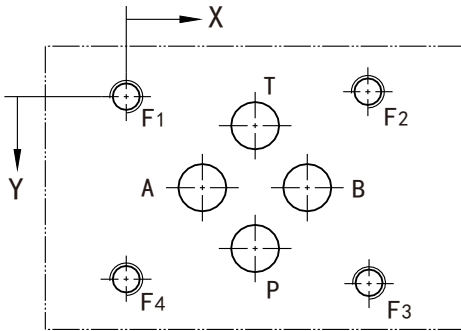

	4-M5 Deep 10				4- φ 7.6max			
X	0	40.5	40.5	0	12.7	21.5	30.2	21.5
Y	0	-0.75	31.75	31	15.5	5.1	15.5	25.9
Code	F1	F2	F3	F4	A	T	B	P

Note: The tolerance for each hole dimension is ±0.1.

● **Nominal size 10**

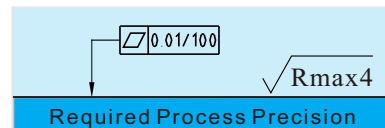
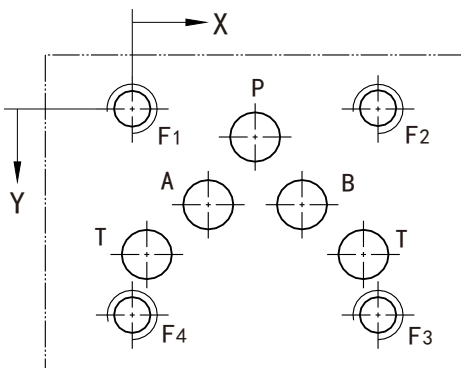

	4-M6 Deep 12				5- φ 10.5max				
X	0	54	54	0	16.7	3.2	50.8	37.3	27
Y	0	0	46	46	21.4	32.5		21.4	6.3
Code	F1	F2	F3	F4	A	T		B	P

Note: The tolerance for each hole dimension is ±0.1.